

MBE 9A8

8 Zylinder COP 1-8-4-3-6-5-7-2

2 Lambda

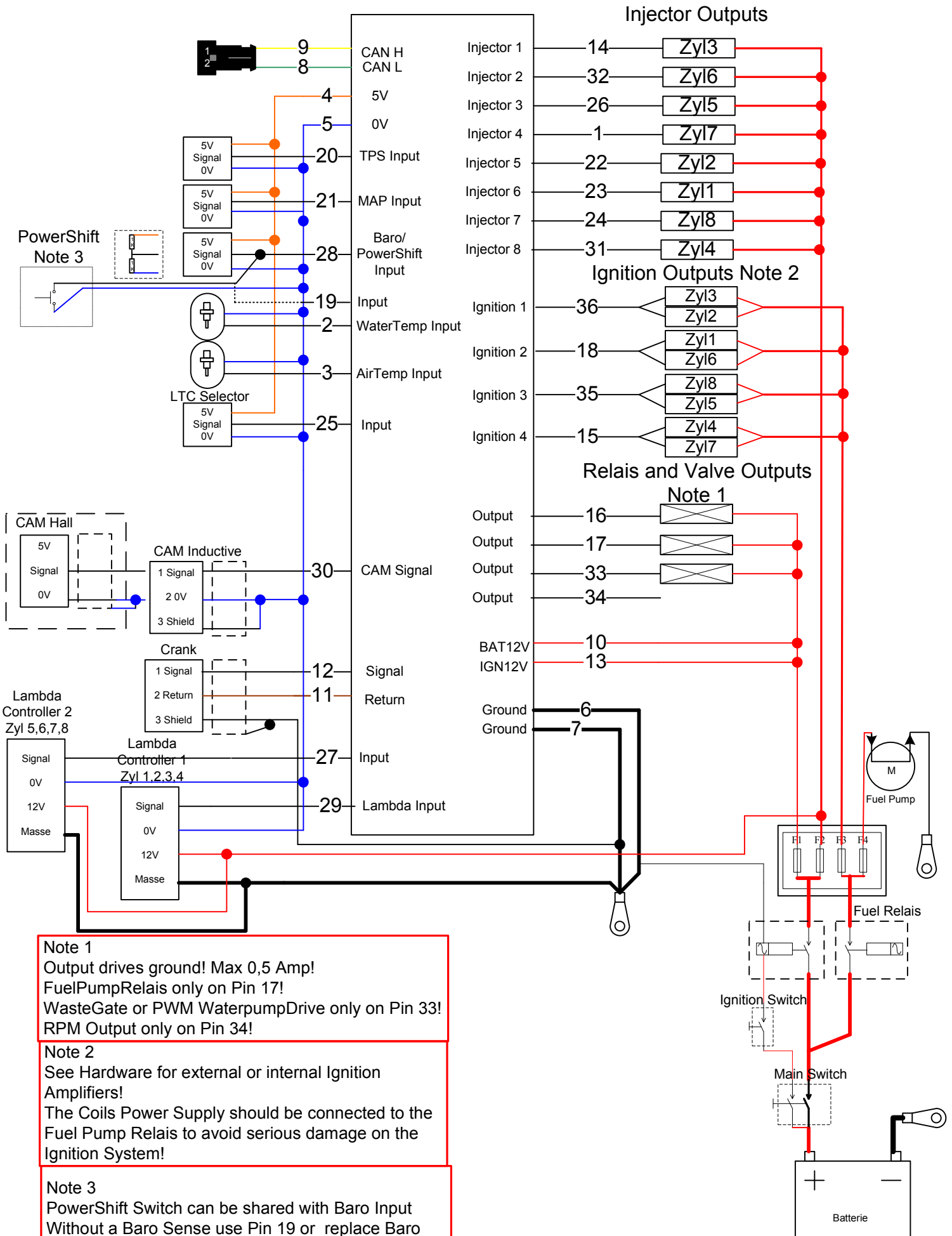

Note 1
 Output drives ground! Max 0,5 Amp!
 FuelPumpRelais only on Pin 17!
 WasteGate or PWM WaterpumpDrive only on Pin 33!
 RPM Output only on Pin 34!

Note 2
 See Hardware for external or internal Ignition Amplifiers!
 The Coils Power Supply should be connected to the Fuel Pump Relais to avoid serious damage on the Ignition System!

Note 3
 PowerShift Switch can be shared with Baro Input
 Without a Baro Sense use Pin 19 or replace Baro Sense with Resistors!